

Technický popis $V = 4000l$

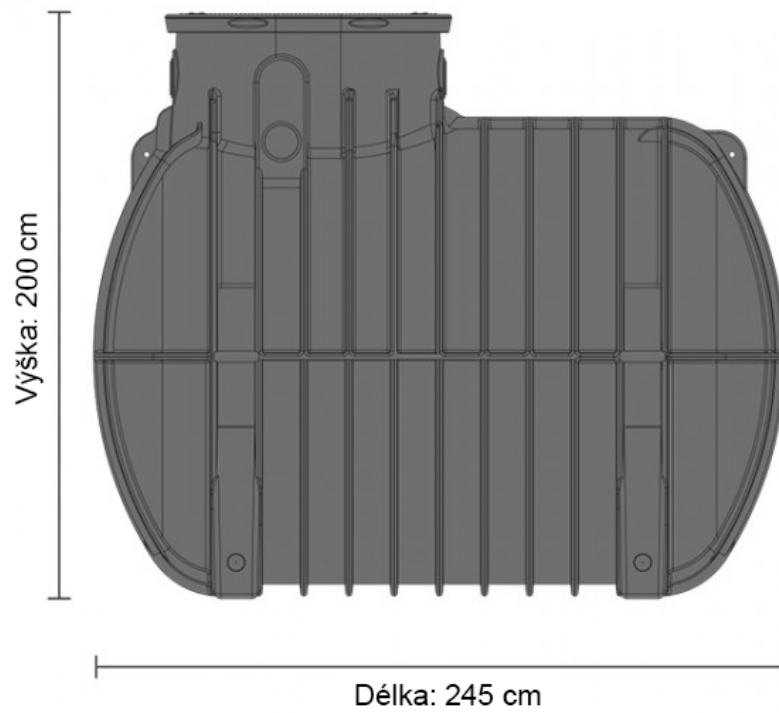

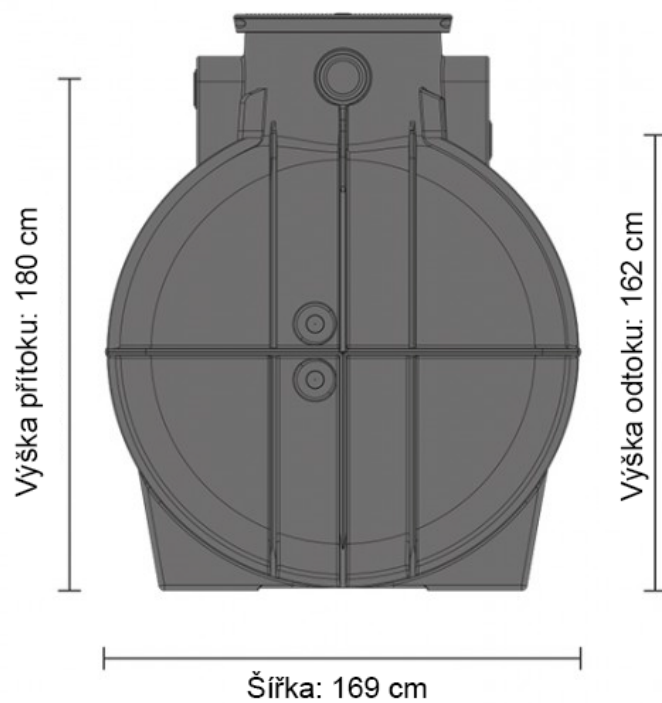

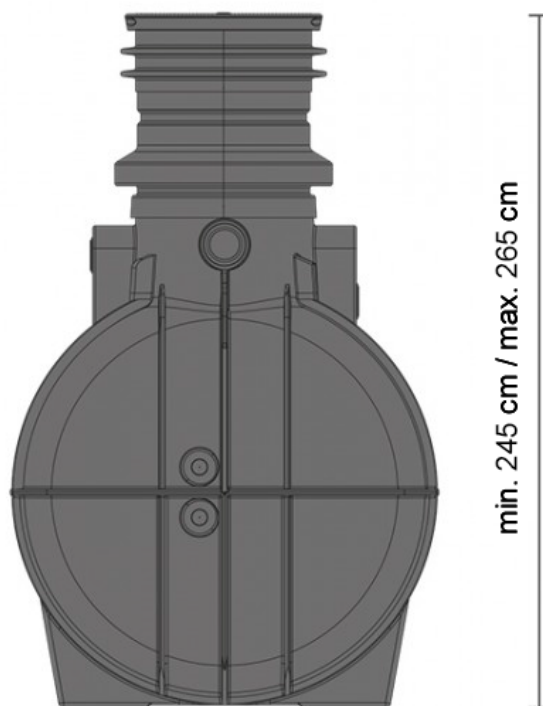

Nádrž s komínem