

Technický popis $V = 5000l$

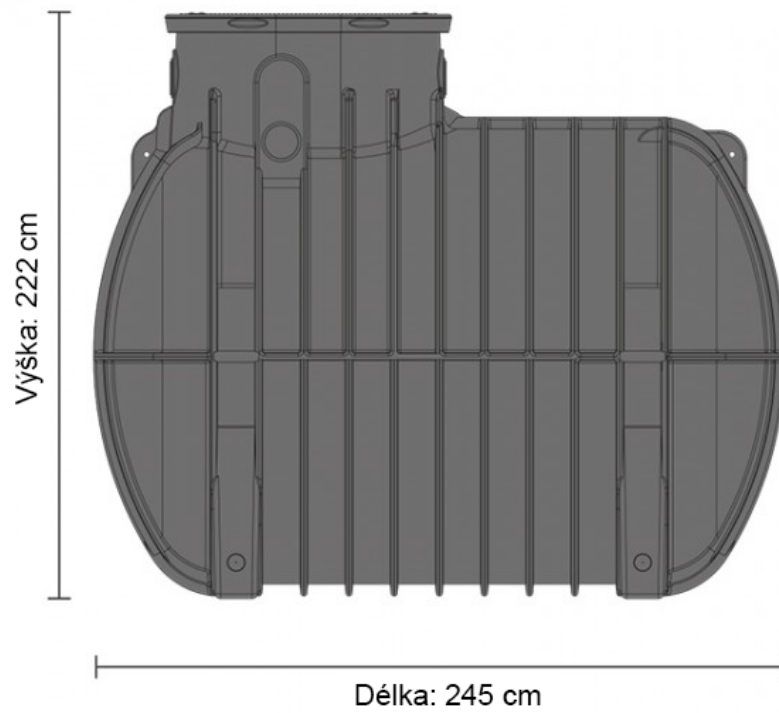

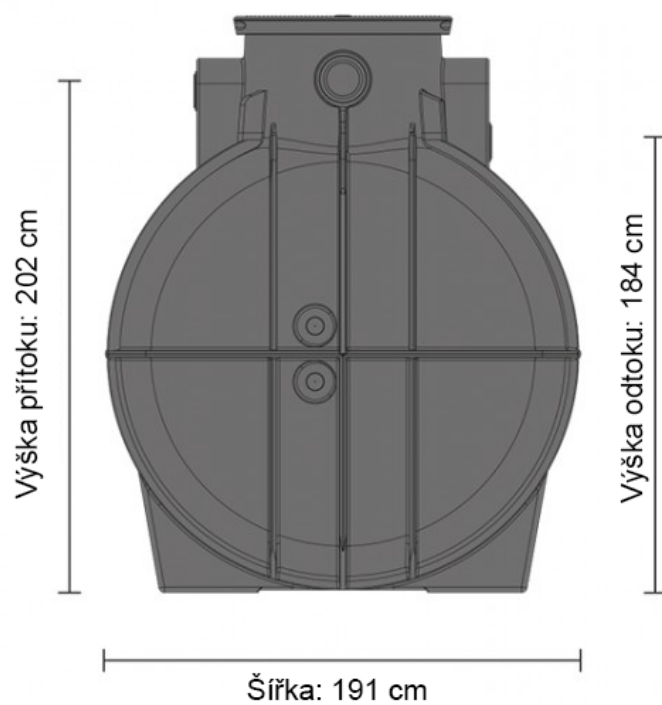

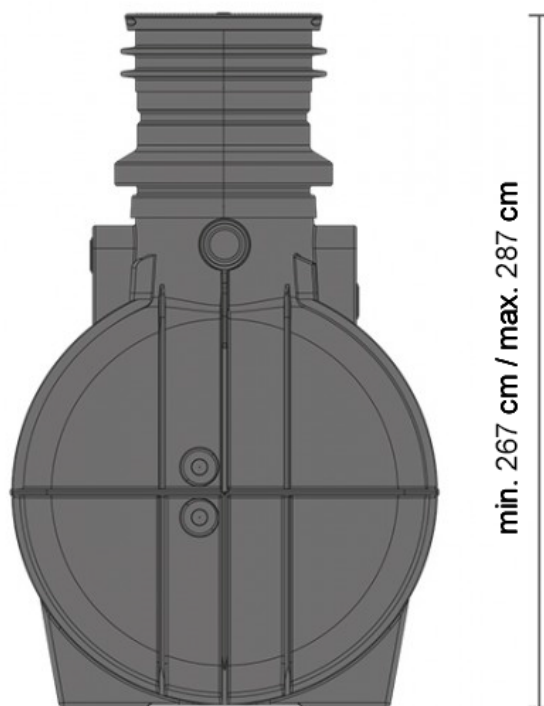

Nádrž s komínem